

# ZB4BK1343

red illuminated selector switch head Ø22 3-  
position stay put



## Main

Range of product	Harmony XB4
Product or component type	Head for illuminated selector switch
Product compatibility	Integral LED
Device short name	ZB4
Bezel material	Chromium plated metal
Mounting diameter	22 mm
Sale per indivisible quantity	1
Shape of signaling unit head	Round
Type of operator	Stay put
Operator profile	Red standard handle
Operator position information	3 positions +/- 45°

## Complementary

CAD overall width	29 mm
CAD overall height	29 mm
CAD overall depth	43 mm
Product weight	0.036 kg
Resistance to high pressure washer	7000000 Pa at 55 °C, distance: 0.1 m
Mechanical durability	500000 cycles
Electrical composition code	M4 for <= 4 contacts using single and double blocks in front mounting with integral LED M10 for <= 2 contacts using single blocks in front mounting with integral LED M6 for <= 2 contacts using single blocks in front mounting with integral LED and transformer M3 for <= 4 contacts using single blocks in front mounting with integral LED

## Environment

Protective treatment	TH
Ambient air temperature for storage	-40...70 °C
Ambient air temperature for operation	-25...70 °C
Class of protection against electric shock	Class I conforming to IEC 60536
IP degree of protection	IP69K conforming to IEC 60529
NEMA degree of protection	NEMA 4X NEMA 13
IK degree of protection	IK06 conforming to IEC 50102
Standards	CSA C22-2 No 14 EN/IEC 60947-1 EN/IEC 60947-5-1 EN/IEC 60947-5-4 EN/IEC 60947-5-5 JIS C 4520 UL 508
Product certifications	BV CSA DNV GL LROS (Lloyds register of shipping) RINA UL listed

---

Vibration resistance	5 gn (f = 2...500 Hz) conforming to IEC 60068-2-6
Shock resistance	50 gn for 11 ms half sine wave acceleration conforming to IEC 60068-2-27 30 gn for 18 ms half sine wave acceleration conforming to IEC 60068-2-27

---

Dimensions

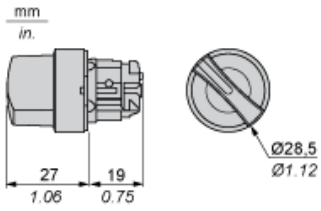

Panel Cut-out for Pushbuttons, Switches and Pilot Lights (Finished Holes, Ready for Installation)

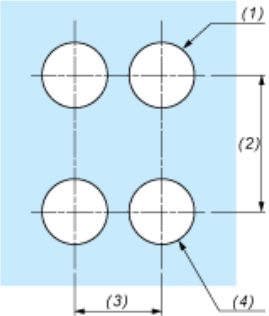
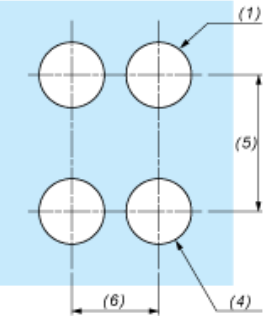
Connection by Screw Clamp Terminals or Plug-in Connectors or on Printed Circuit Board	Connection by Faston Connectors
	
<p>(1) Diameter on finished panel or support                  (2) 40 mm min. / 1.57 in. min.                  (3) 30 mm min. / 1.18 in. min.                  (4) <math>\varnothing 22.5 \text{ mm} / 0.89 \text{ in.}</math> recommended (<math>\varnothing 22.3 \text{ mm}_0^{+0.4} / 0.88 \text{ in.}_0^{+0.016}</math>)                  (5) 45 mm min. / 1.78 in. min.                  (6) 32 mm min. / 1.26 in. min.</p>	

Pushbuttons, Switches and Pilot Lights for Printed Circuit Board Connection

Panel Cut-outs (Viewed from Installer's Side)

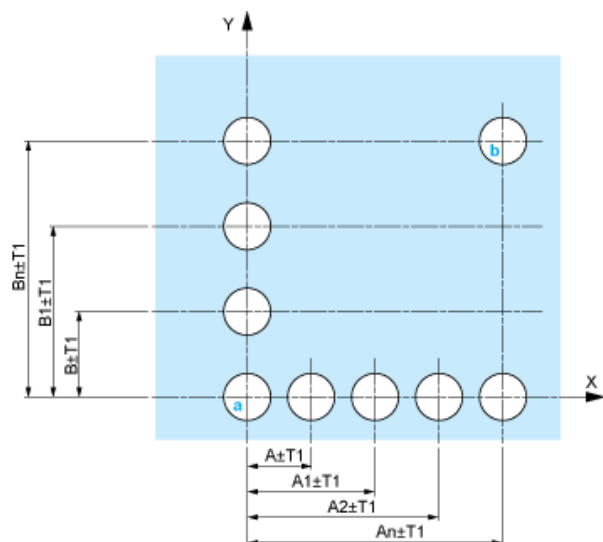

- A: 30 mm min. / 1.18 in. min.  
 B: 40 mm min. / 1.57 in. min.





- (1) Panel  
(2) Printed circuit board

### Mounting of Adapter (Socket) ZBZ 01•

- 1 2 elongated holes for ZBZ 006 screw access
- 2 1 hole  $\varnothing$  2.4 mm  $\pm$  0.05 / 0.09 in.  $\pm$  0.002 for centring adapter ZBZ 01•
- 3 8  $\times$   $\varnothing$  1.2 mm / 0.05 in. holes
- 4 1 hole  $\varnothing$  2.9 mm  $\pm$  0.05 / 0.11 in.  $\pm$  0.002, for aligning the printed circuit board (with cut-out marked a)
- 5 1 elongated hole for aligning the printed circuit board (with cut-out marked b)
- 6 4 holes  $\varnothing$  2.4 mm / 0.09 in. for clipping in adapter ZBZ 01•

Dimensions An + 18.1 relate to the  $\varnothing$  2.4 mm  $\pm$  0.05 / 0.09 in.  $\pm$  0.002 holes for centring adapter ZBZ 01•.

---

Electrical Composition Corresponding to Code M3

---

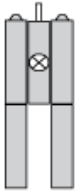

---

Electrical Composition Corresponding to Code M4

---

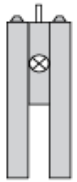

---

Electrical Composition Corresponding to Codes M6 and P2

---

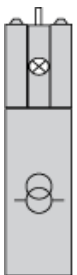

---

Electrical Composition Corresponding to Codes M5, M10, MF1, MR1 and MF2

---

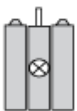

---

Legend

---

Single contact



Double contact



Light block







Possible location



### Sequence of Contacts Fitted to 3-position Selector Switch Body





Position 315°



Push	Position	Top			
Bottom					
Location		Left	Right		
State		1	0		
Contacts	N/O		closed	open	
N/C		open	closed		

Position 0°



Push	Position	Top			
Bottom					
Location		Left	Right		
State		0	0		



Contacts	N/O	open	open
N/C		closed	closed

Position 45°



Push	Position	Top			
Bottom					
Location		Left	Right		
State		0	1		
Contacts	N/O	open	closed		
N/C		closed	open		