











Collar de protección para pulsador de seta de Parada de emergencia, con o sin cerradura Ronis, diseño de 22 mm, amarillo, material plástico



nombre comercial del producto	SIRIUS ACT
designación del producto	Collar de protección
tipo de producto	para pulsador de seta de parada de emergencia sin cerradura o con cerradura RONIS
denominación del tipo de producto	3SU1
Datos técnicos generales	
grado de protección IP	IP66, IP67, IP69(IP69K)
grado de protección NEMA	1, 2, 3, 3R, 4, 4X, 12
Directiva RoHS (fecha)	10/01/2014
Condiciones ambiente	
temperatura ambiente	-40 ... +80 °C
• durante el almacenamiento	
Instalación/ fijación/ dimensiones	
altura	58,9 mm
anchura	74,8 mm
profundidad	47,5 mm
Accesorios	
material del accesorio	Plástico
color del accesorio	amarillo
Certificados/ Homologaciones	
General Product Approval	Declaration of Conformity
 Confirmation	   
Test Certificates	Marine / Shipping
Type Test Certificates/Test Report	    
other	Environment
Confirmation	Environmental Con-

Más información

Información sobre el embalaje

<https://support.industry.siemens.com/cs/ww/es/view/109813875>

Information- and Downloadcenter (Catálogos, Folletos,...)

<https://www.siemens.com/ic10>

Industry Mall (sistema de pedido online)

<https://mall.industry.siemens.com/mall/es/es/Catalog/product?mlfb=3SU1900-0DY30-0AA0>

Generador CAx online

<http://support.automation.siemens.com/WW/CAxorder/default.aspx?lang=en&mlfb=3SU1900-0DY30-0AA0>

Service&Support (Manuales, certificados, características, FAQ,...)

<https://support.industry.siemens.com/cs/ww/es/ps/3SU1900-0DY30-0AA0>

Base de datos de imágenes (fotos de producto, dibujos acotados 2D, modelos 3D, esquemas de conexiones, macros EPLAN, ...)

http://www.automation.siemens.com/bilddb/cax_de.aspx?mlfb=3SU1900-0DY30-0AA0&lang=en

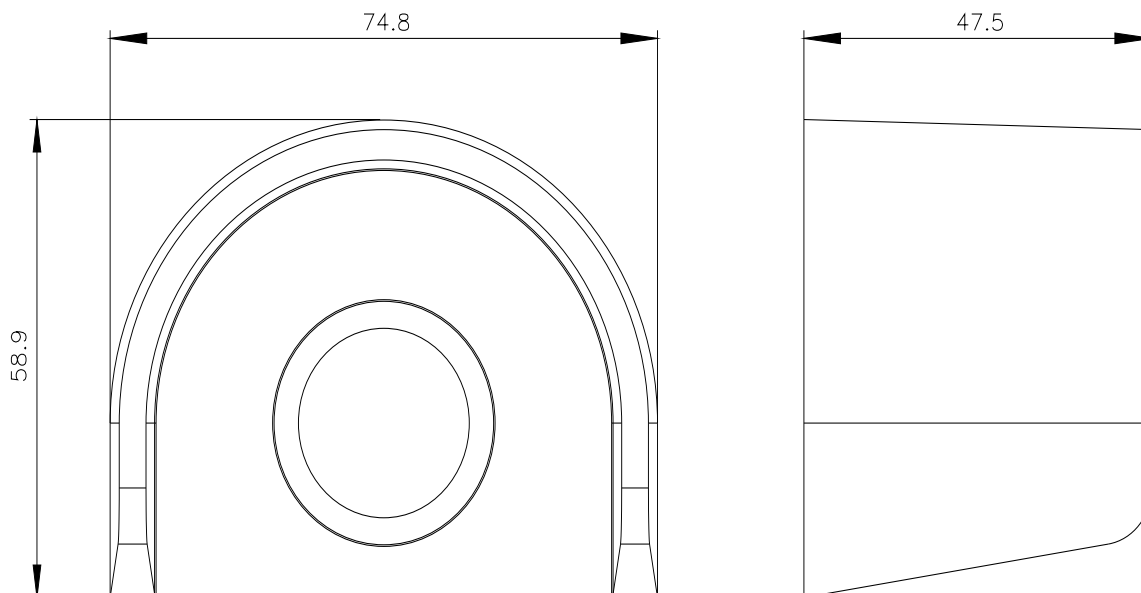

Última modificación:

18/1/2023 